

I

O - 149

Progress Report Concerning  
International Atomic Energy Agency  
Research Contract

No.: 37.

December 1959 - August 1960.

Reporter: Cand. real. O.M. Skulberg.

1.8.1960

Progress Report concerning International  
Atomic Energy Agency Research Contract  
No. 37.

Covering the Period December 14th 1959 to August 1st 1960.

From the Norwegian Institute for Water Research,  
Blindern, Norway.

## Foreword.

This paper presents an account of the work carried out in cooperation between the Institute for Atomic Energy and the Norwegian Institute for Water Research on the International Atomic Energy Agency Research Contract No. 37 for the first period of seven months and a half.

The activities during this period were mainly concentrated upon preparations for the experiments in the model recipient, including trying out of methods and procedures for the investigations, and the detailed design and construction of the experimental plant.

The work with those arrangements for the experiments in the model recipient has unfortunately partly been delayed by unforeseen complications.

Difficulties have arisen in connection with the situation of the experimental plant within the area of the military air field Kjeller. The extreme weather conditions this summer, with a downfall in Skedsmo of 187,4 mm in July, have also meant special impediments. Altogether this and other problems of interference has caused a delay of about one and a half months for the research contract plans.

However, our aims are so far fulfilled, as on the 1st of August the system of canals and tanks were tried with water, and the undertakings in the model recipient can now be entered upon.

In the course of the last week of April we had the honour of a visit paid by Professor Sc.D. Rolf Eliassen, Massachusetts Institute of Technology. For this stimulating contact, with the interesting discussion that followed, we are very grateful.

We would like to express our gratitude to the International Atomic Energy Agency for the manner in which our research program is superintended.

For the Norwegian Institute for Water Research

*Olav Skulberg*

Olav Skulberg

Table of contents:

Section:	Page:
1. River water as substrate for algal growth.	1
2. Experiments with planktonic algae.	4
2.1. The organisms used in the experiments.	4
2.2. Culture medium, implements and the growing of the algae.	5
2.3. Important chemical and radiochemical methods employed.	8
2.4. Experiments carried out.	11
3. The experimental plant.	11
3.1. The channel system.	12
3.2. The well system.	12
4. Influence of building materials upon water quality, and the trying out of details of constructions.	15
5. Ending remarks.	16
List of illustrations.	17

1. River water as substrate for algal growth.

The purpose of this work was to get experience for a more concrete understanding of the properties of the actual river water as substrate for the growth of autotrophic algae. Such knowledge is of a certain importance in our further study of the effects of introducing the wastes of atomic energy production into this specific water. Then the amounts and availability of the various nutrients are intimately connected with the specific water quality. The categories of nutrients occurring may be summarized in this way: Dissolved, adsorbed in exchangeable form, bound in nonexchangeable form and present in soluble and insoluble form in particles. Their mode of existence and change from one form to the other will be special in the individual water-masses, and is of paramount interest in the studying of phenomena related to absorption of substances by organisms. This is indicated in the fact that the presence of one ion in the medium may affect the absorption of another ion, for instance that under corresponding conditions generally the uptake of radioactive isotopes by aquatic plants from soft water is greater than uptake from hard water.

The river Nitely flows gently through a landscape of gneissic and plutonic rocks covered chiefly with glacial-fluvial and marine deposits of sand and clay, the latter being of greatest quantity. With respect to the meteorological conditions an annual average downfall of 840 mm and a year medial temperature of  $+3,8^{\circ}\text{C}$  gives Martonne's hygrotermic figure a value of 61. The final community in the ecological succession of vegetation in the region being coniferous forest.

The water trickling through this drainage basin will dissolve small quantities only of inorganic substances. As

a consequence the water accumulating to make the river being a very dilute solution of alkaline earth and alkali bicarbonate and carbonate with a variable quantity of minor inorganic constituents in true solution. This circumstance is reflected in the average value for electrolytical conductivity which is of the order ( $\kappa_{18} = n \cdot 10^{-6}$ ) 50. Some ionic constituents in so far as they determine the chemical characteristics of the water, is listed below:

Constituent	Average value
Ca <sup>++</sup>	5,4 mg/l
Mg <sup>++</sup>	1,3 "
Fe <sup>++</sup> , Fe <sup>+++</sup>	0,3 "
SO <sub>4</sub> <sup>==</sup>	7,0 "
Cl <sup>-</sup>	4,3 "
H <sub>3</sub> O <sup>+</sup>	7,1 pH

There is also a variety of colloidal and suspended materials of both inorganic and organic origin. The turbidity of the water corresponds to a magnitude of 9,0 mg SiO<sub>2</sub>/l.

Concentrations of all the components mentioned is of course varying with locality and fluctuating with season and weather conditions prevailing.

Water masses with qualities as described give under the actual climatic conditions rise to a floristic very diverse planktonic algal vegetation. However, what the standing crop of phytoplankton concerns, it will usually be found rather small, commonly of a magnitude 10<sup>5</sup> algal cells/l.

In the part of the river where the water intake to the model recipient is situated, the river is carrying a certain load of pollution from drainage of cultivated soil and sewage from populated areas. As a consequence

the water masses are here considerably enriched. The effect on the growth of algae is easily demonstrated. The following experiment is illustrative. River water from 3 different sampling stations classified as unpolluted, polluted, and heavy polluted, was collected and 300 ml measured into 750 ml Erlenmeyer flasks. After sterilization in autoclave of 3 parallels of each water sample, they were inoculated with cells of the green alga Selenastrum capricornutum from a stock culture. The cells transformed were thoroughly washed by repeated centrifugation in distilled water. The Erlenmeyer flasks were placed under illumination from fluorescent lamps and left for twenty days, the cultures only each morning stirred up. After this period the number of cells in each culture vessel were counted with the inverted microscope technique. The result is listed below, figures represent algal yields as cells/l.

Sampling station unpolluted:	Sampling station polluted:	Sampling station heavy polluted:	Synthetic nutrient solution:
1 . 10 <sup>5</sup>	6,5.10 <sup>6</sup>	2,7.10 <sup>8</sup>	
2,5 . 10 <sup>5</sup>	7,3.10 <sup>6</sup>	3,1.10 <sup>8</sup>	2.10 <sup>9</sup>
	9,1.10 <sup>6</sup>	7,6.10 <sup>8</sup>	

It is apparant that biological essential substances have entered the water with the polluting material and support a considerable development of algae.

Nitrogen and phosphorous generally have been reckoned to the nutrient elements most likely to limit growth of phytoplankton. Observational data from the natural locality are not adequate in ascertaining which element or substance else may be available in least abundant supply relative to the actual requirements for growth of the algae. We are now employing an experimental procedure based upon determination of growth of selected algae in definite volumes



of the river water after enrichment with various combinations of essential mineral elements. The results so far obtained are not conclusive.

## 2. Experiments with planktonic algae.

The intention with these experiments are twofold, they are objects in trying out important methods and gives an introduction to the work with the uptake of radioactive isotopes by organisms in the first trophic level of the food chain. The investigational effort was planned in two phases. The initial undertaking was directed towards laboratory work with algae under conditions of culture, the second part will center around studying the absorption concentration of radioactivity by selected algae under approximately natural circumstances.

### 2.1. The organisms used in the experiments.

The quantitatively most important components in the standing crop of phytoplankton in the lower part of the river Nitely are representatives for the classes Chlorophyceae and Schizophyceae. During the summer and autumn 1958 fairly high population densities of species in the orders Chlorococcales and Hormogonales appeared quickly and persisted for weeks in the water masses. Selenastrum capricornutum and Pseudanabaena sp., both algae exerting at times a major controlling influence of the phytoplankton community by virtue of their numbers, were chosen as objects for the experimental work.

Selenastrum capricornutum Printz. The strain used for the experiments was isolated from a net-sample taken in the river when the species was predominant. This alga is growing very well in ordinary mineral solutions used (Chu, Knop, Molisch). Selenastrum capricornutum can live under strictly autotrophic conditions. It is, however, not tested if the growth can be stimulated by admixture of organic substances. When liquid media is used subcul-

tures are made at 3 weeks intervals. A stock culture with the original clone of Selenastrum capricornutum employed in our work with uptake of radioactive isotopes is maintained permanently in our laboratory collection of algae. Figure 1 represents a microphotography of the actual alga, cell dimensions being approx. 2.15 microns.

Pseudanabaena Lautertorn sp. This alga has not been positively identified as a member of Pseudanabaena, but it possesses most of the diagnostic characteristics attributed to the genus. The identification of the species requires more consideration.

It proved rather difficult to succeed in keeping this alga under laboratory conditions. The ordinary nutrient solutions tested were not suitable for continuous growth of the representative organism. But after some trial and error we mastered the technique.

From a heavy suspension of the alga in the river, small portions were inoculated in a large number of culture vessels with the nutrient solution. A mixture of species grew up as a consequence. From cultures in which Pseudanabaena sp. was most abundant additional subcultures were prepared. In this way continued uni - algal cultures were obtained. Also this clone is permanently maintained in our laboratory collection of algae.

Figure 2 represents a microphotography of the actual alga, trichome diameter approx. 2 microns.

## 2.2. Culture medium, implements and the growing of the algae.

The composition and concentration of the nutrient solution used are given as follows:

$\text{NaNO}_3$	467,0 mg/l
$\text{Ca}(\text{NO}_3)_2 \cdot 4\text{H}_2\text{O}$	59,0 "
$\text{K}_2\text{HPO}_4$	31,0 "
$\text{MgSO}_4 \cdot 7\text{H}_2\text{O}$	25,0 "
$\text{Na}_2\text{CO}_3$	21,2 "

In addition:

Fe-Komplexon III	0,5 mg $\text{Fe}^{3+}$ /l
Gaffron trace element solution	0,8 ml/l

This solution has previously been used in American laboratories and is designated Z8. In preparing the nutrient medium we experienced a difficulty in connection with the autoclaving, that was a tendency of precipitation of phosphates. To avoid this and to get a really satisfactory medium a special procedure for the preparation was worked out. The difficulty was settled by the use of distilled water saturated with carbon dioxide for dissolving the different substances, and then establish defined conditions for the autoclaving.

In all the experiments culture vessels made of glass of Pyrex quality were employed. Mostly Erlenmeyer flasks of volume 750 ml served the purpose. They were stoppered by a foliage of aluminium and moreover covered with halves of small Petri dishes.

The algae were grown in artificial light illuminated by fluorescent lamps. The light outside the culture vessels represented round about 100 footcandles. The temperature in the room where the cultivation was performed varied between 21 - 23°C.

The growth of the algae was followed by regular observations of population densities in the culture vessels and determinations of important chemical changes in the nutrient solution. An example of the development of an algal popu-

lation of Selenastrum capricornutum in a laboratory culture is given in figure 3. Turbidity is used as a parameter for the growth. The relationship between cell number and turbidity is demonstrated in the graph in figure 4.

It has been necessary to work out a method which makes it possible to use an optic measurement of the algal population to express gravimetric relations. The determination of turbidity was found usable. The following table and the graph in figure 5 gives an example of the results.

Gravimetric determinations of Selenastrum capricornutum.

Wet weight mg/l	Dry weight		Ash weight		Units of turbidity $n \cdot 10^{-3}$
	mg/l	% of wet weight	mg/l	% of dry weight	
298	5,3	1,8	0,35	6,6	1,04
359	6,3	1,8	0,5	7,9	-
496	11,7	2,4	-	-	1,62
967	20,2	2,1	1,3	6,4	3,42
1493	26,7	1,8	1,7	6,4	4,80
1762	38,2	2,2	2,6	6,8	-
1920	38,4	2,0	2,5	6,5	6,20
2413	40,5 <sup>x)</sup>	1,7	2,4 <sup>x)</sup>	5,9	7,20
2989	53,6	1,8	3,6	6,7	8,00 <sup>x)</sup>
3193	68,4 <sup>x)</sup>	2,1	5,5 <sup>x)</sup>	8,0	9,80
4693	-	-	-	-	14,00
4972	77,9	1,6	5,7	7,3	12,40 <sup>x)</sup>

x) Values marked with asterisk not used in drawing the calibration curves.

In order to obtain larger yield of algae for managing special problems a growth unit for this purpose was adapted. This unit is shown diagrammatically in figure 6. A short explanation is necessary. The culture vessel to the right on the figure is a 10 l glass retort containing usually 5 l nutrient solution and illuminated by Philips TL 40W/32

fluorescent lamps. Factors of the chemical milieu in the culture vessel can be regulated through adjustment of the content of carbon dioxide in the solution. When the gas is distributed to the culture liquid the pressure is measured manometrically and the volume controlled by use of a flow - meter and a check-watch. The growth of alga in this unit is followed with systematic determination of hydrogen ion concentration and electrolytic conductivity measurement, and pH is continually held in the interval 7-8 with the carbon dioxide admixture. In this way a stable culture is approximately established with a population density of round about  $10^9$  cells/l. The cultures usually reached their equilibrium population within fourteen days.

### 2.3. Important chemical and radio-chemical methods employed.

$P^{32}$  and  $Cs^{134}$  have been used to study the uptake of radioactive cesium and phosphorus in the two algae Selenastrum capricornutum and Pseudanabaena sp.

$Cs^{134}$  was chosen as a representative of the cesium-isotopes.  $Cs^{134}$  has a half life of 2,3 years and emits beta-particles with an energy of 0,65 Mev (72 - 75 %) and 0,09 Mev (24 - 28 %), and gamma rays of mainly 0,60 and 0,79 Mev. This is very convenient since both the beta and gamma emission can be used for the detection and measurement of  $Cs^{134}$ . Approximately  $1/\mu c$  of  $Cs^{134}$ , as  $CsCl$ , is added to each sample, the  $CsCl$  has a specific activity of 50 mc  $Cs^{134}$  per gram of cesium, thus only  $20/\mu g$  of inactive cesium is added together with the radioactive material.

$P^{32}$  is a pure beta-emitting isotope, with  $E_{max}$  1,7 Mev. The  $P^{32}$  is added to the samples from a neutral solution of orthophosphate. The phosphorus has a specific activity of 100 mc  $P^{32}$  per gram of phosphorus, so that only  $10/\mu g$  of phosphor is added with the radioactive material. This

amount is neglectable compared with the phosphorous content of the culture medium.

After having been in contact with the radioactive material for the prescribed time, the samples are removed from the light. The flask is shaken vigorously, and 75 ml of the suspension is immediately filtered through a membrane filter (Spezial-Membran filter Co 5).

At the same time aliquots of the suspension are measured out for biological determination and for turbidity measurement.

The filtrate is transferred to a clean bottle, and the filter with the algae is washed with distilled water. The filter is then ready for radiochemical determinations. From the filtrate aliquots are measured out for activity measurement, and for the determinations of nitrogen and phosphorus. The pH value and the conductivity are determined in the filtrate immediately after filtration.

P<sup>32</sup>. A 2 II proportional counter (flow-counter) has been used to standardize the P<sup>32</sup>-solution. The routine measurement of P<sup>32</sup> in algae and in the solution has been carried out with a Geiger-Müller counter, which in turn has been standardized against the 2 II-proportional counter. Correction has to be made for backscattering and selfabsorption of the beta-particles.

The filter with the algae is transferred to an Al-counting disk, the filter is dissolved in acetone and dried under an infrared lamp. The sample is then ready for counting. 1 ml of the filtrate is evaporated on an Al-counting disk and counted.

Cs<sup>134</sup>. The Cs<sup>134</sup>-solution has been standardized by counting the beta activity in a 2 II proportional counter. A scintillation well-counter has been used for the routine measurement of activity. The scintillation counter also can

be connected to a single channel analyser - to give a separation of the Cs<sup>134</sup> activity.

The filter with the algae is transferred to a 5 ml polyethylene vial which fits into the counter. 3 ml of the solution is pipetted into the same type of vial and counted.

All samples are counted to give at least 10,000 counts in order to obtain a standard deviation of  $\pm 1$  per cent.

Absorption of activity to the glass has caused some difficulties. Further investigations of this absorption effect is in progress.

Phosphorus in the culture medium was determined using a method described in "Standard Methods for Examination of Water, Sewage and Industrial Wastes". The orthophosphate is determined colorimetrically, using ammoniamolybdate to form the phosphomolybdate-complex, which is reduced with stannous chloride. The transmission of the sample was measured in an Elko II colorimeter.

Nitrate nitrogen was determined after a method described in "Standard Methods for Examination of Water, Sewage and Industrial Wastes". The nitrate reacts with 1,2,4 phenoldisulfonic acid to form 6 nitro - 1,2,4 phenoldisulfonic acid, which upon conversion to the ammonia salt yields a yellow colour, suitable for colorimetric measurement. The Elko II colorimeter is used to measure the transmission.

pH. The pH value was measured with Beckman pH-metre.

Electrolytical conductivity was observed with a Philips conductivity measuring bridge PR 9500 and measuring cell. All the readings are performed at 20°C.

Turbidity. The turbidity of the algal suspension was measured in a Sigrist - Photometer UP 2/LD, for some determinations an Elko II colorimeter was used.

#### 2.4. Experiments carried out,

By means of methods and equipment above mentioned, the following problems were dealt with:

- 1) January 3rd - March 2nd, 1960. Variations in the culture medium related with autoclaving, storage and growth of algae.
- 2) February 8th - March 11th, 1960. Absorption of Cs<sup>134</sup> and P<sup>32</sup> by *Selenastrum capricornutum* in a long period of time.
- 3) March 28th - April 7th 1960. Absorption of Cs<sup>134</sup> and P<sup>32</sup> by *Selenastrum capritornutum* the first 24 hours after contamination with the radioactive substance.
- 4) May 2nd. - May 16th 1960 and June 10th - June 24th 1960. Absorption of Cs<sup>134</sup> and P<sup>32</sup> by *Pseudanabaena* sp. the first 24 hours after contamination with the radioactive substance.
- 5) June 14th - July 6th 1960. The magnitude of the component processes adsorption and intrability in the phenomenon of absorption of Cs<sup>134</sup> and P<sup>32</sup> by *Selenastrum capricornutum*.

The results so far obtained are instructive. But perhaps the most important profit has been the experience which they have given us in the various fields of work necessary to master in approaching the realization of the aims pursued in this project.

#### 3. The experimental plant.

The plant consists of two major parts: The channel system and the well system. For the relative arrangement of these systems in the actual situation figure 7 gives an impression.



### 3.1. The channel system.

This part of the experimental plant is built up of 5 channels with a continuous addition of river water, and 1 channel with a constant volume of water and recirculation of the water masses. Each of these channels have a total length of 120 m. Cement - asbest channels are used for this purpose, they are prefabricated and are suspended on wooden poles as shown in drawing figure 8. The addition of river water to the throughflow-channels is regulated by means of a free jet method whereby the discharge can be varied in 5 different stages. The apparatus used for this purpose is shown in drawing figure 9. By varying the discharge to each channel from 0,5 - 1,5 l/sec. the corresponding velocities in the channels will be 2,5 - 7,5 cm/sec. respectively.

In the recirculation channel the water is given a velocity by means of a paddle. By means of an electric motor, with stepless variation of numbers of revolutions per minute, for driving the paddle. The water masses can in this way be given any wanted velocity.

### 3.2. The well system.

From the constant-level tank the water is added in one plastic-hose which leads to a sedimentation tank giving the water a detention time of about 1/2 hour at a total flow of 3 l/sec. The sedimentation tank also acts as a constant level tank for the 9 prefabricated concrete-wells connected in parallel. The level of the water surface in the sedimentation tank is kept constant by means of a float-controlled valve on the inflow side.

The wanted throughflow in each well is controlled by means of needle valves in stainless steel, while the depth of water in each well can be regulated as wanted by means of a movable overflow device.

The throughflow channels and the well system are supplied with river water from a continuously working centrifugal pump with a capacity of round about 10 l/sec. The water is conveyed on to the plant by means of a plastic pipe with a diameter of 4 inches. This pipe ends in a constant head tank situated in the control building, from which the water is distributed to the different parts of the experimental plant. All excess water is taken care of by an overflow weir in the constant head tank and carried to the main river. For the whole system of pipings in the plant there is used plastic material exclusively.

From both the channel and well system the water used is carried in cement-asbest channels back to the river. Water containing radioactive materials is, by means of another set of channels, lead into a nearby pond, for giving detention time before it is added back to the river. The use of an ion exchange method is planned for removal of radioactive substances in those cases where the concentration is above a certain limit, and when particularly dangerous isotopes are distributed in the water masses.

The following dates characterizes the experimental plant:

1) Recirculation channel.

Water volume:  $(120 \cdot 0,1 \cdot 0,2) \text{m}^3 = 2400 \text{ litres.}$

Wet perimeter:  $((0,2 + 0,2) \cdot 120) \text{m}^2 = 48 \text{ m}^2.$

2) Throughflow channels.

Velocity of the water (V m/sec.) at 10 cm water level:

Q	0,5 l/sec	0,75 l/sec	1,0 l/sec	1,25 l/sec	1,5 l/sec
V	2,5 cm/sec	3,75 cm/sec	5 cm/sec	6,25 cm/sec	7,5 cm/sec

Time for the replacement of the water (t min):

Q	0,5 l/sec	0,75 l/sec	1,0 l/sec	1,25 l/sec	1,5 l/sec
T	80 min.	53 min.	40 min.	32 min.	27 min.

Wet perimeter:  $((0,2 + 0,2) \cdot 120)m^2 = 48 m^2$ .

Discharge (litres for one channel):

Q \ t	0,5 1/sec.	0,75 1/sec.	1 1/sec.	1,25 1/sec.	1,5 1/sec.
1 min.	30 l	45 l	60 l	75 l	90 l
1 hour	1800 l	2700 l	3600 l	4500 l	5400 l
24 hours	43000 l	65000 l	86000 l	108000 l	130000 l

3) The well system.

Water volume in one tank (d = 160 cm, A = 2 m<sup>2</sup>):

Water level (h)	25 cm.	50 cm.
Volume of water	500 litres	1000 litres

Wet perimeter:

Water level	25 cm.	50 cm.
Wet perimeter	3,25 m <sup>2</sup>	4,5 m <sup>2</sup>

Time for the replacement of the water (t min):

h \ Q	0,5 1/sec.	0,75 1/sec.	1 1/sec.	1,25 1/sec.	1,5 1/sec.
25 cm	17 min.	11 min.	9 min.	7 min.	6 min.
50 cm	34 min.	22 min.	18 min.	14 min.	12 min.

Discharge (litres for one tank):

Q \ t	0,5 1/sec.	0,75 1/sec.	1 1/sec.	1,25 1/sec.	1,5 1/sec.
1 min.	30 l	45 l	60 l	75 l	90 l
1 hour	1800 l	2700 l	3600 l	4500 l	5400 l
24 hours	43000 l	65000 l	86000 l	108000 l	130000 l

The figures 10 - 13 represents characteristic views of the experimental plant. Explanations, see list of illustrations.

4. Influence of building materials upon water quality, and the trying out of details of construction.

In connection with the planning and the building of the experimental plant a range of small experiments and tests has been undertaken. The intention of these have been to try out details of the construction and to control the reaction on organisms of the building materials.

The most important of this work center around the following problems:

- 1) Changes in the chemical properties of the water by transfluxion in pipes of cement and cement - asbest channels. Distilled water and water of the Nitely river have been tested.
- 2) Reaction of the water on different organisms after its contact with types of building material. Poison effects and stimulating effects are considered.
- 3) The influence of the building materials on radiologic conditions in the water.
- 4) The effect of different types of surface treatment of pipes and channels on relations mentioned above in 1, 2 and 3.

The experiences of these experiments have been a positive aid in determining choice of materials which should be used and their treatment. They will also be of importance for estimates in connection with experiments which are undertaken in the model recipient.

Details of the construction of the experimental plant which has been tried out comprise among other things:

- 1) To make a device for continual dosing of water by a free jet method to the throughflow channels.

- 2) Hanging up of the channels.
- 3) Diverse calibrations in connection with the streaming of water in the plant.
- 4) Construction of a suitable paddle to give the water velocity in the recirculation channel.

Most of the tasks mentioned in this section were performed during the period of time from January to April 1960. The figures 14 - 16 illustrates situations in connection with these undertakings. Short explanations are given in the list illustrations.

5. Ending remarks.

The work which is performed during the period comprised by this report, has been a steady progress for the research project no. 37 of I.A.E.A. The conditions of further work are good, we are well prepared and equipped for the effectuation of the program for the investigation. However, the delay in the building of the model recipient has meant that the range of experiments must now be somewhat different from what was originally pondered. Still, we believe that valuable experiences will be harvested during the work of the autumn months which are now initiated.

LIST OF ILLUSTRATIONS.

Figure:	Page:
1. Selenastrum capricornutum.	18
2. Pseudanabaena sp.	18
3. Growth of Selenastrum capricornutum 8/2 - 11/3 - 1960.	19
4. Relation between number of cells and turbidity in cultures of Selenastrum capricornutum.	20
5. Relation between wet weight, dry weight and ash weight of Selenastrum capricornutum and turbidity of the cultures.	21
6. Diagram of apparatus used for mass-culture of Selenastrum capricornutum.	22
7. Map of area with the experimental plant.	23
8. The channels are suspended on wooden poles.	24
9. Apparatus for the discharge of water to the channels.	25
10. The well system of the experimental plant.	26
11. The channel system of the experimental plant.	26
12. Interior of the controllbuilding.	27
13. The paddle in the recirculation channel.	27
14. The method for supporting the channels is tried out.	28
15. Detail of construction.	28
16. From the laboratory tests of the paddle for the recirculation channel.	28
17. The controllbuilding from outside.	29
18. Detail plan of the controllbuilding.	30
19. Detail plan of the controllbuilding.	31
20. The constant head tank in the controllbuilding.	32
21. Detail plan of installations in the controll- building.	33
22. Plan of the well system.	34

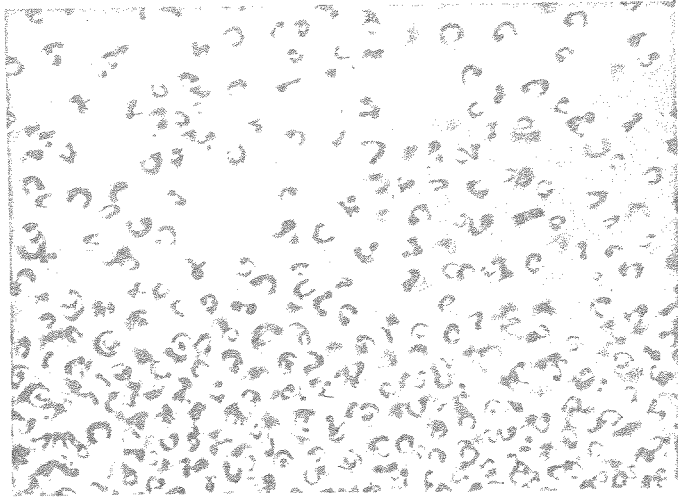

Figure 1.

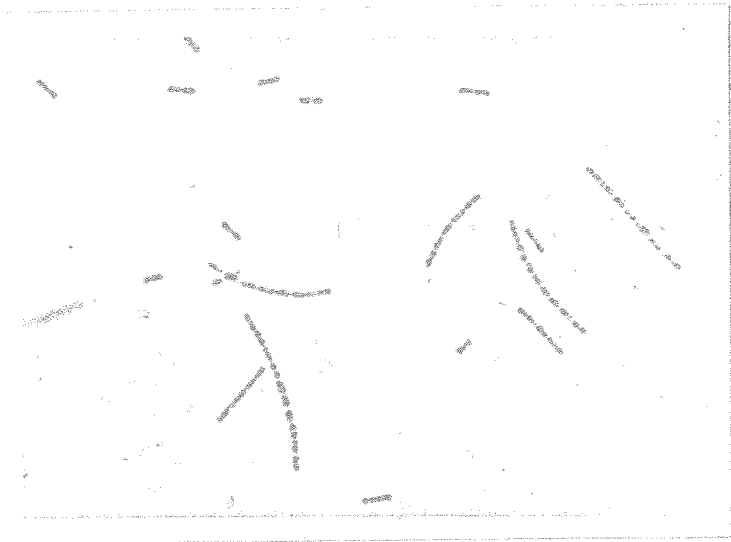
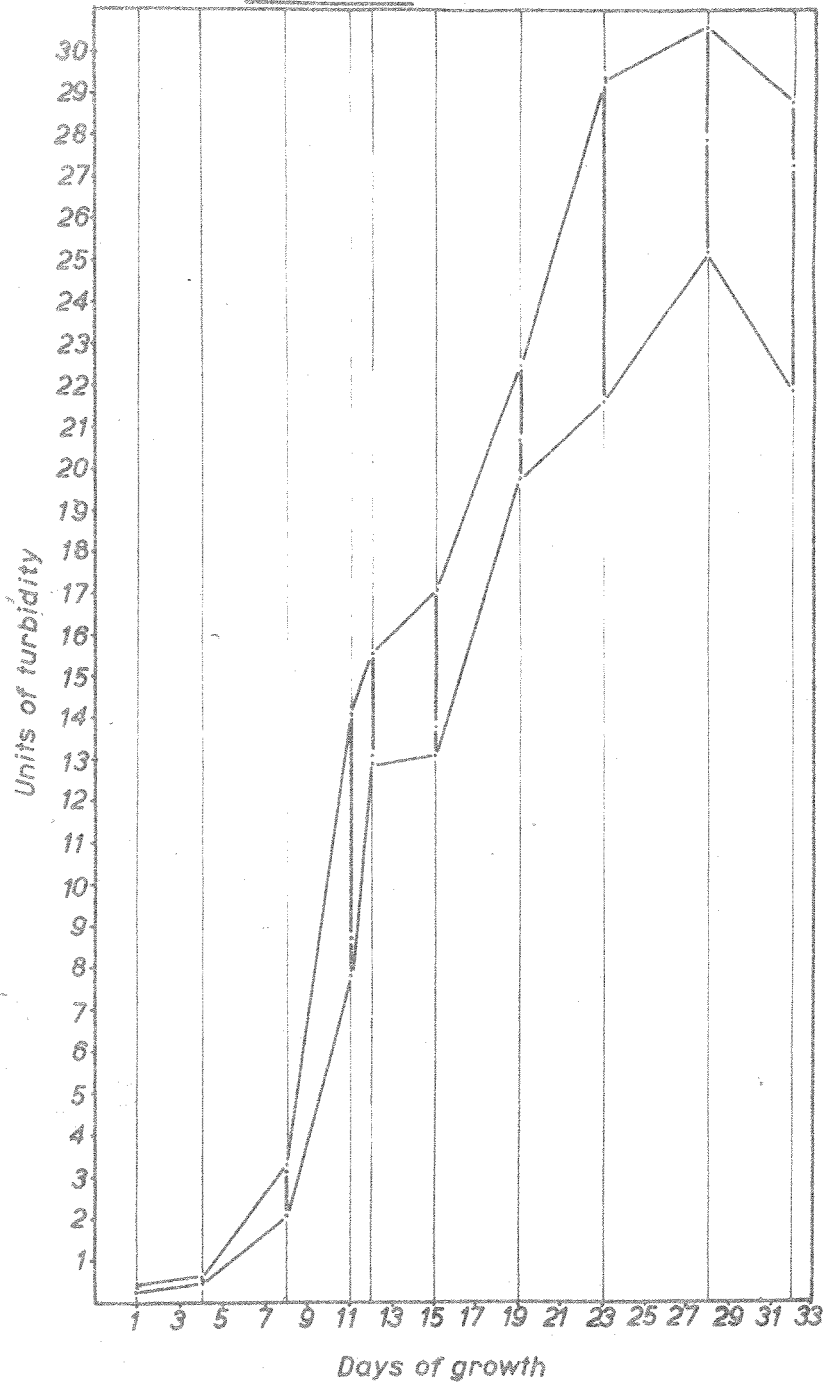

Figure 2.

Growth of *Selenastrum capricornutum* 8.2-  
11.3 1960. Cultures used in experiments  
with Cs 134.





Relation between number of cells and turbidity  
in cultures of *Selenastrum capricornutum*.

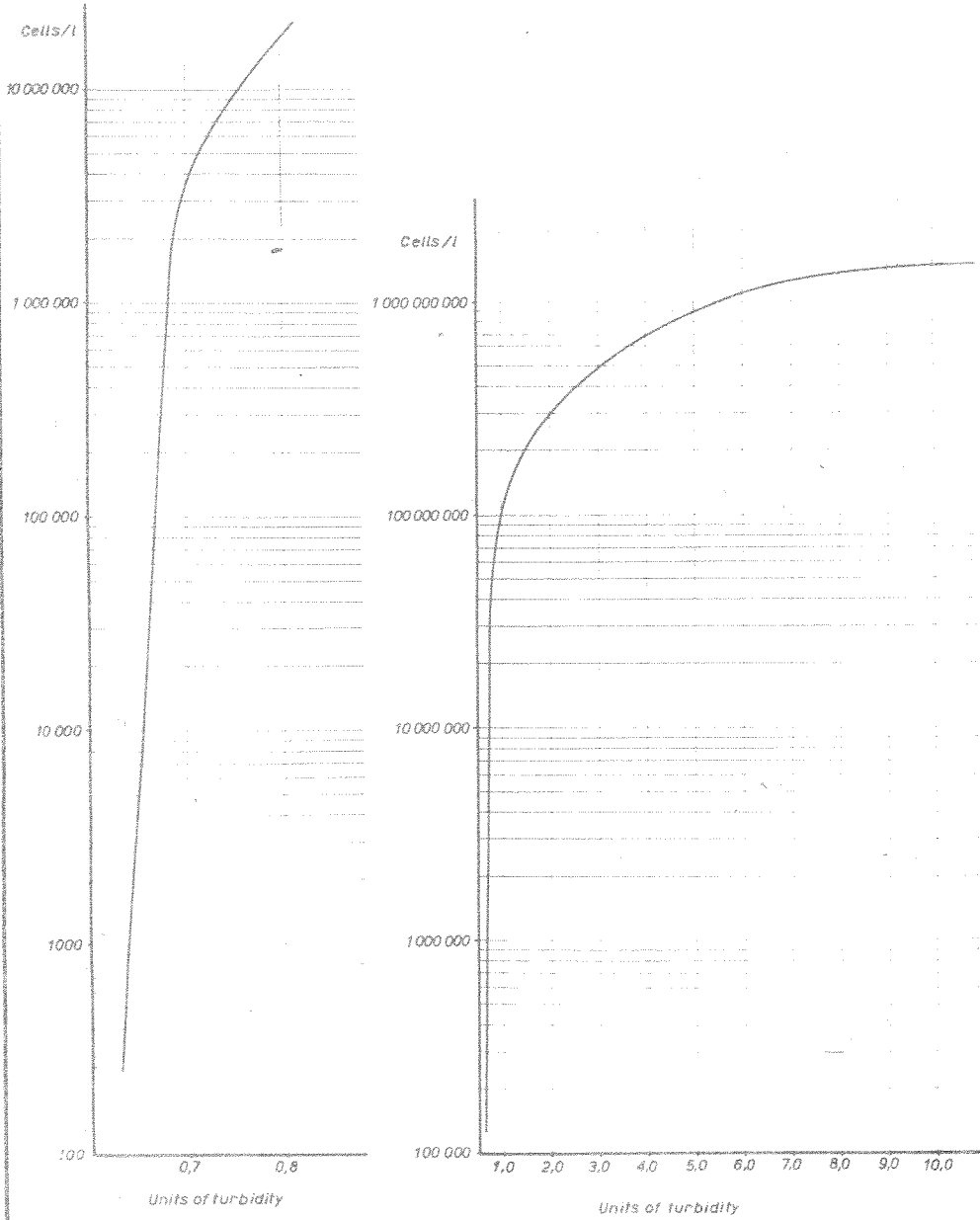

Relation between wet weight and ash weight  
of *Selenastrum capricornutum* and turbidity  
of the cultures.

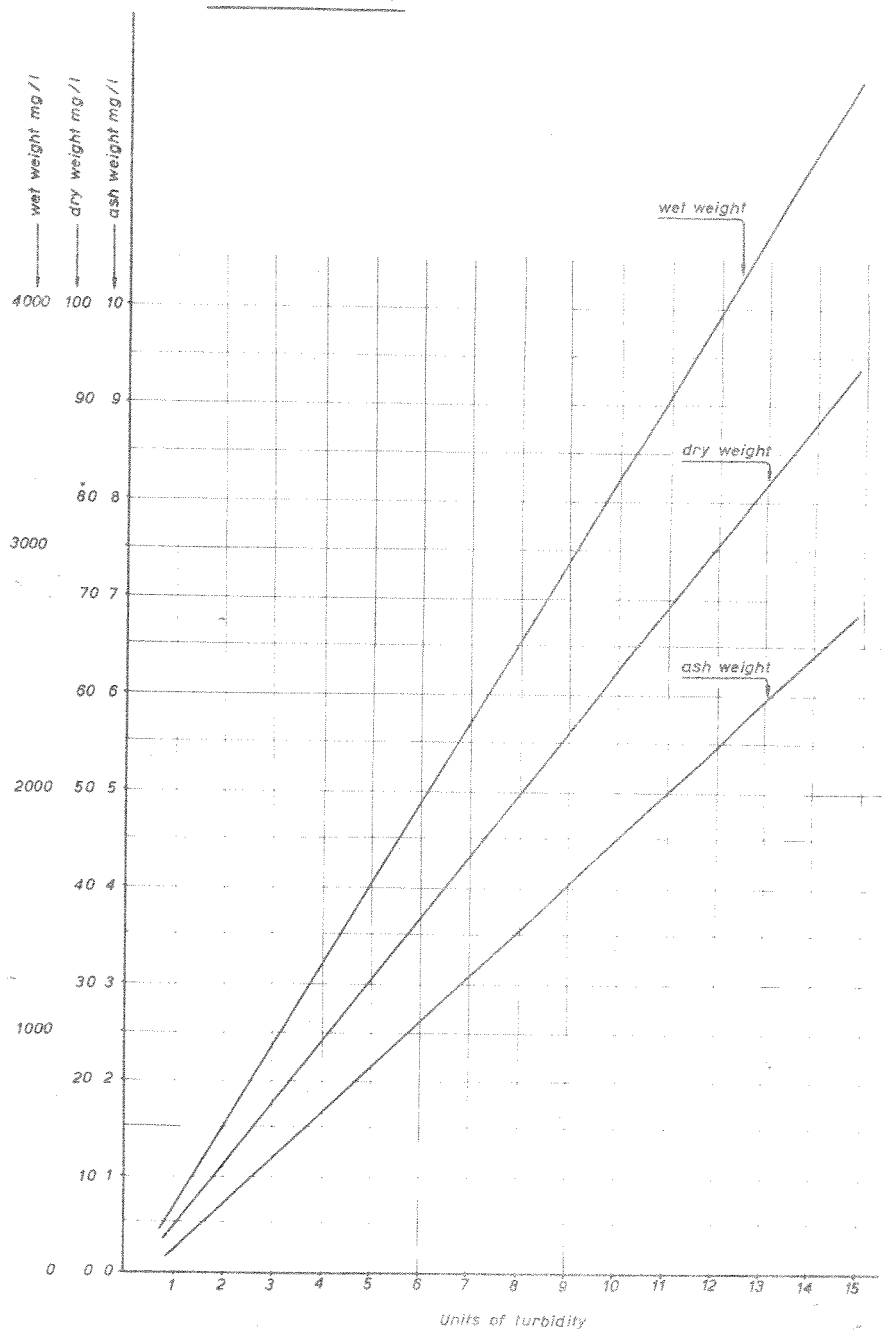

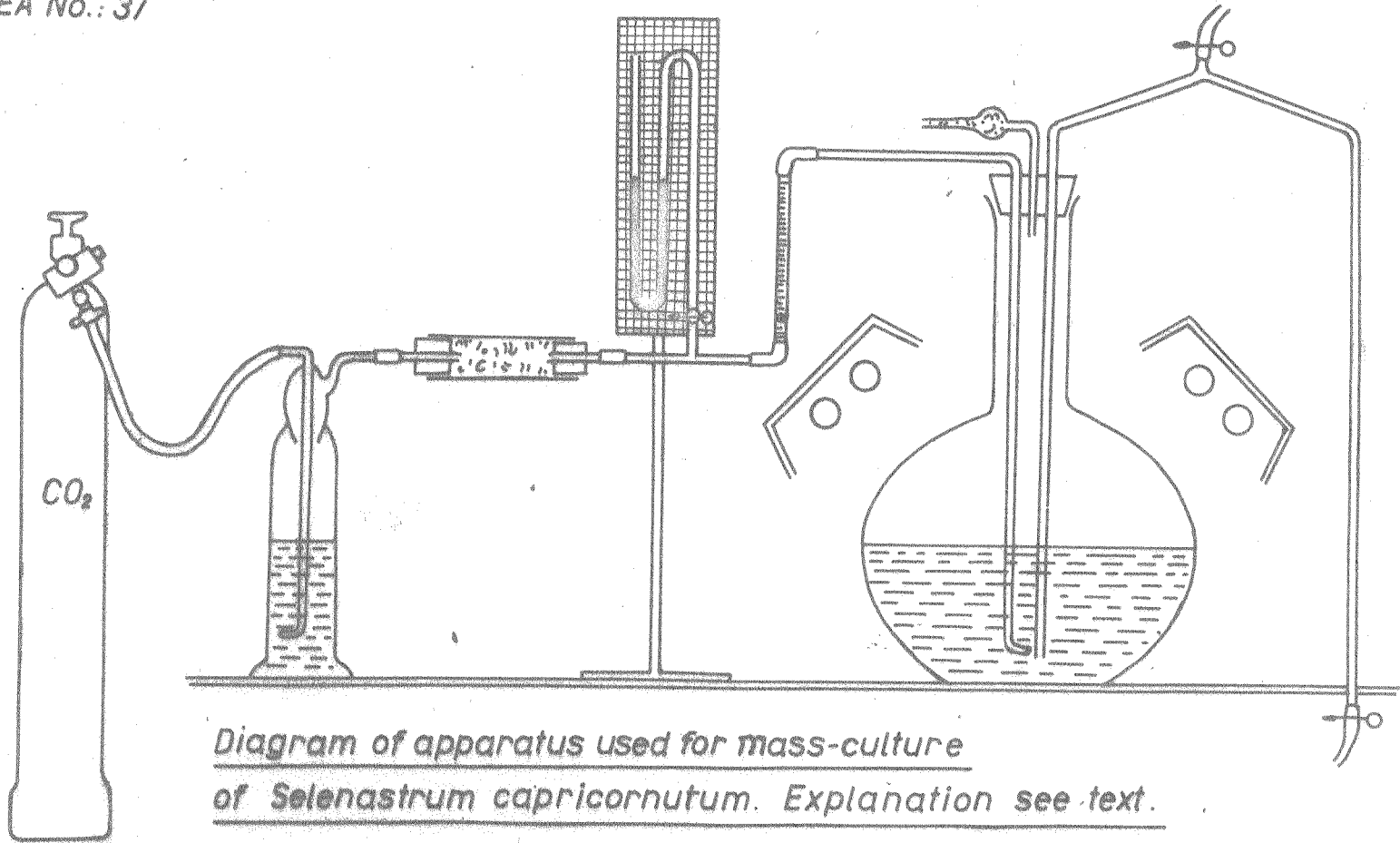
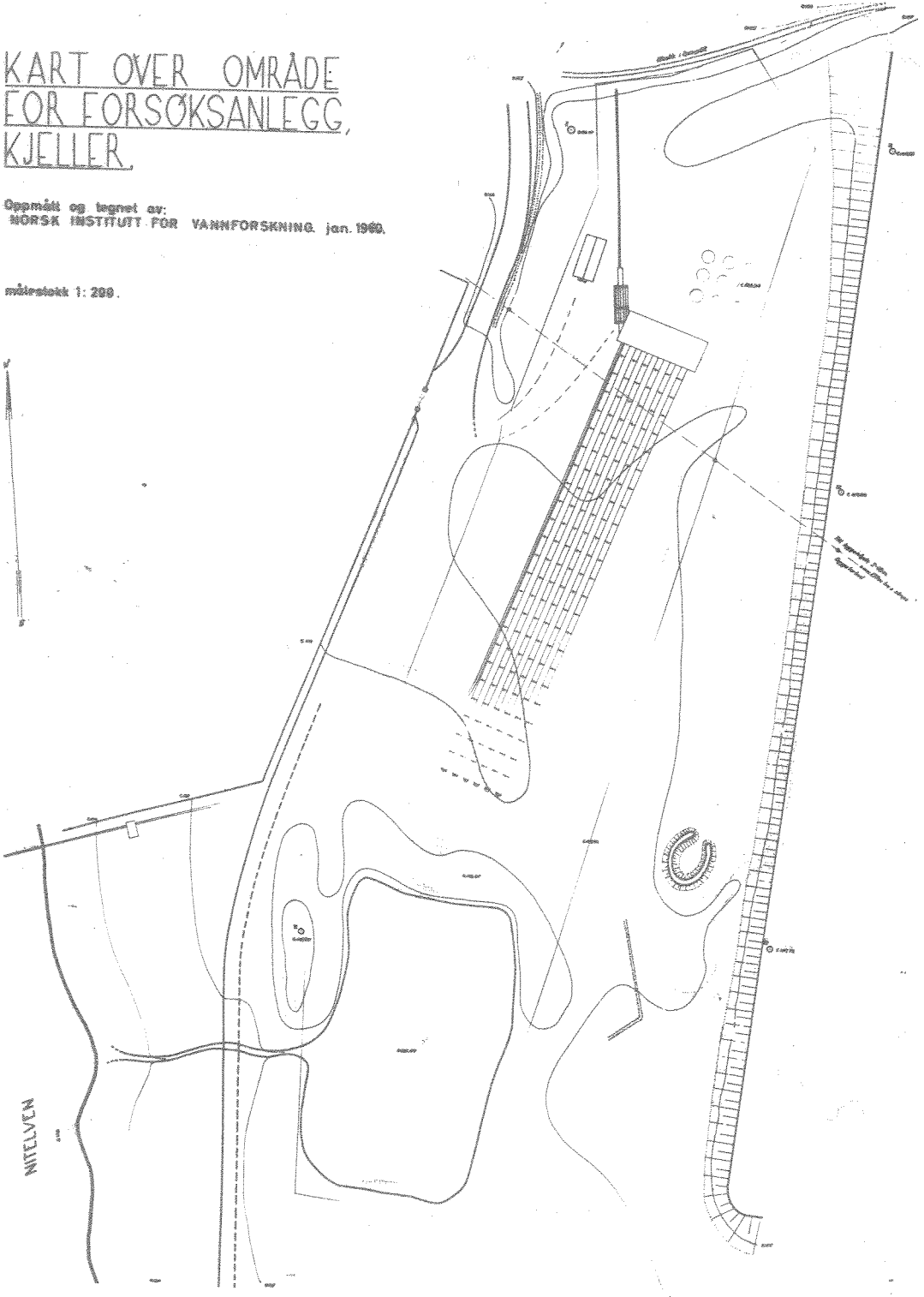

Diagram of apparatus used for mass-culture  
of *Selenastrum capricornutum*. Explanation see text.

# KART OVER OMRÅDE FOR FØRSØKSANLEGG, KJELLER.

Oppmålt og tegnet av:  
NORSK INSTITUTT FOR VANNFORSKNING. jan. 1960.

målestokk 1:200.





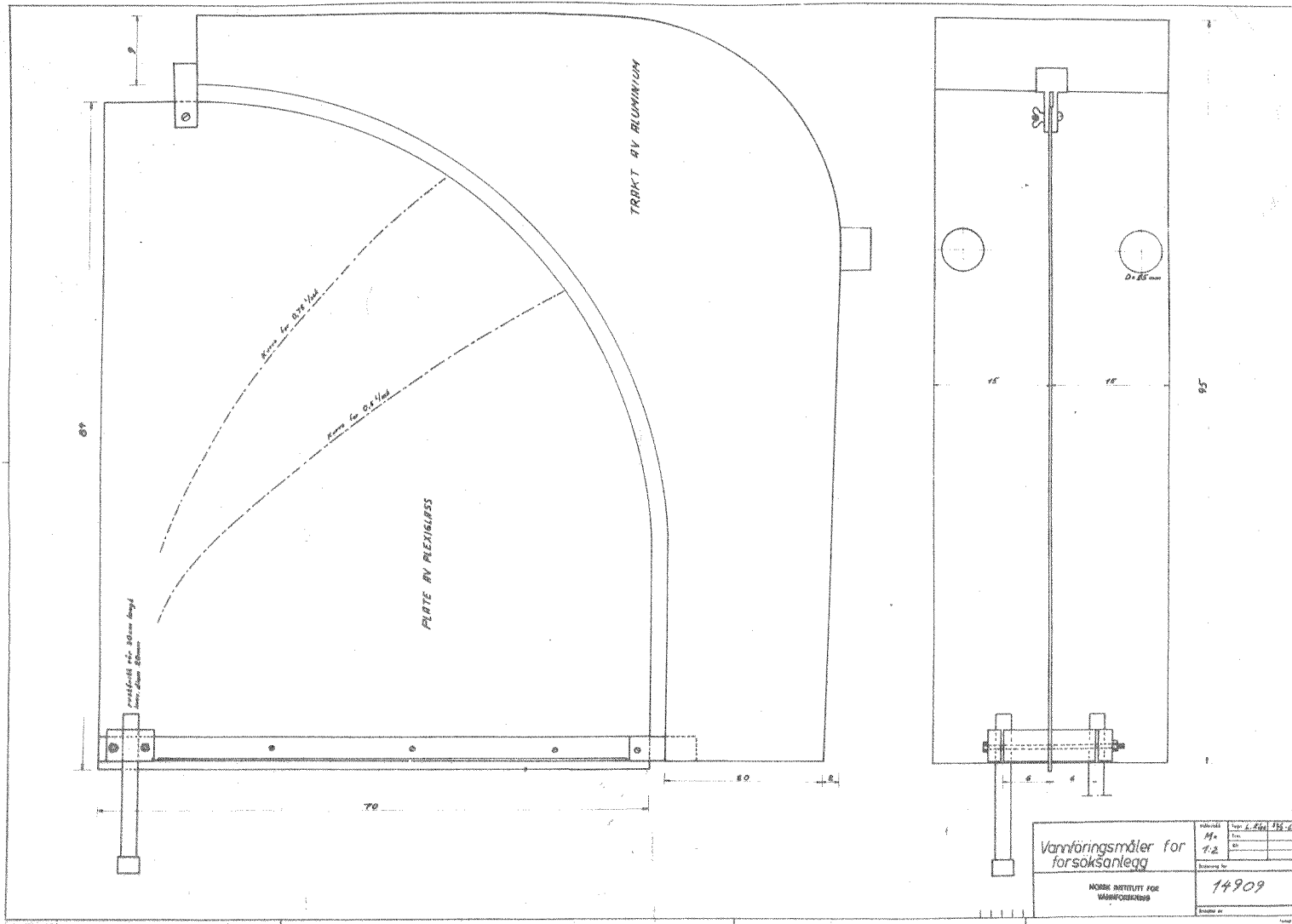

Vannføringsmåler for forsøksanlegg	Modell M- 7.2	Teg. L. 86/1 25.66
	Skaling for 14909	Skaler nr.
NORSK INSTITUTE FOR VANNFORSKNING		Skaler nr.

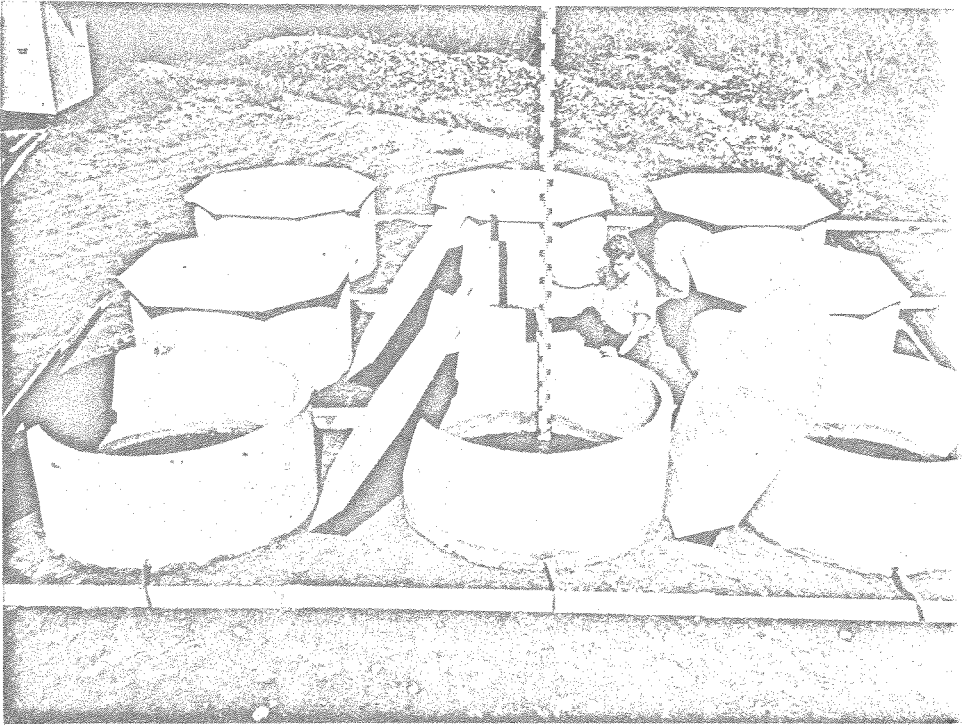

Figure 10.

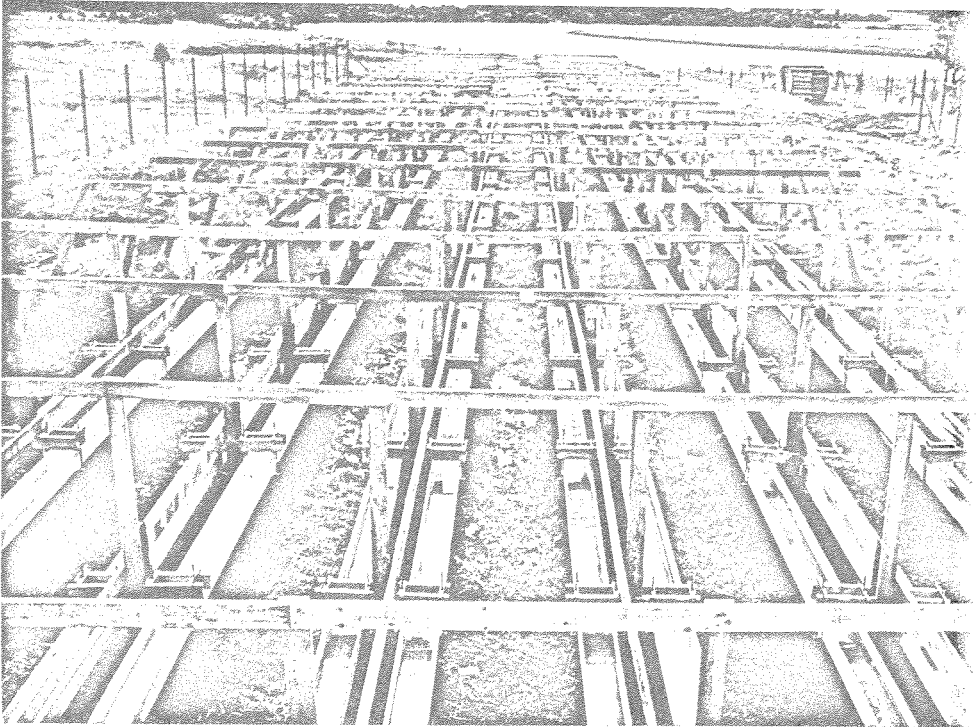

Figure 11.

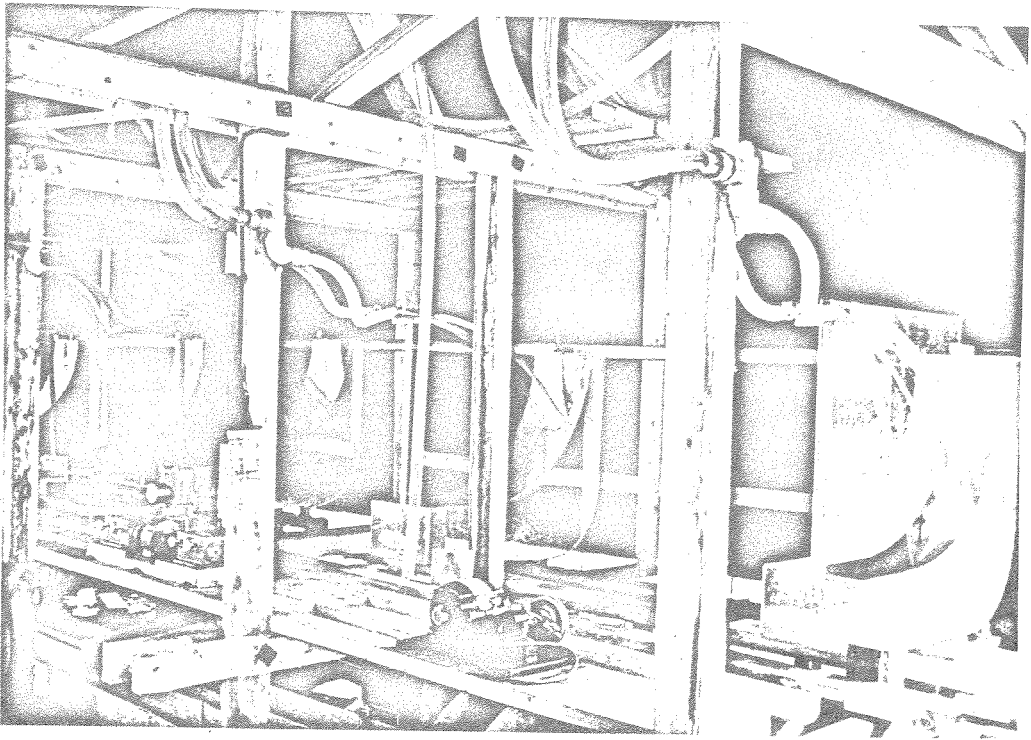

Figure 12.

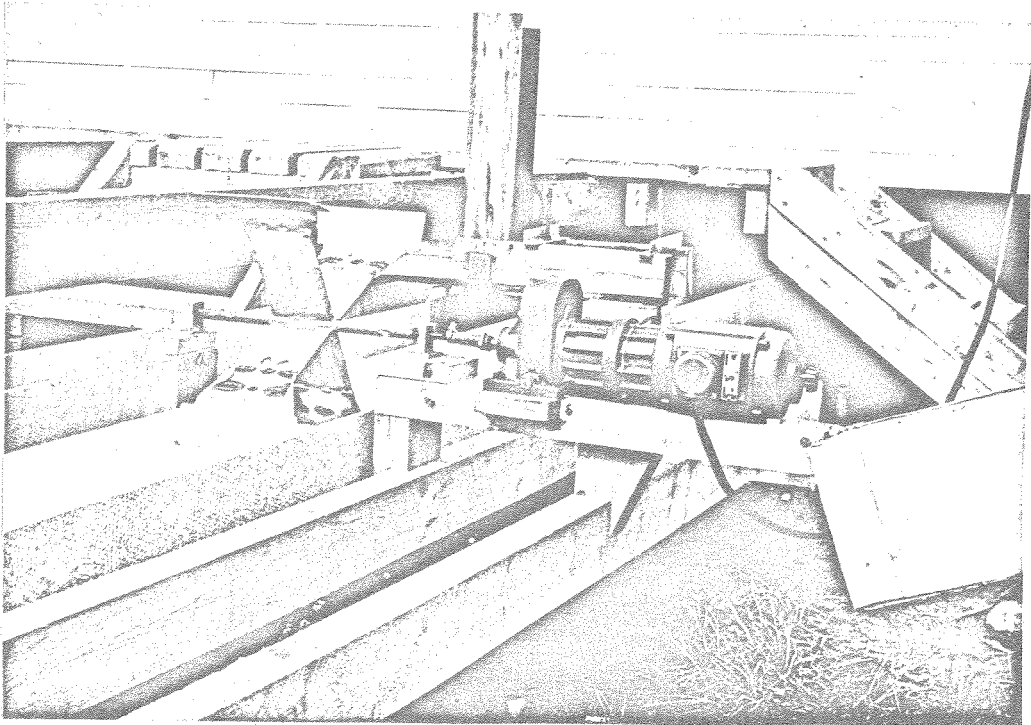

Figure 13.



Figure  
14

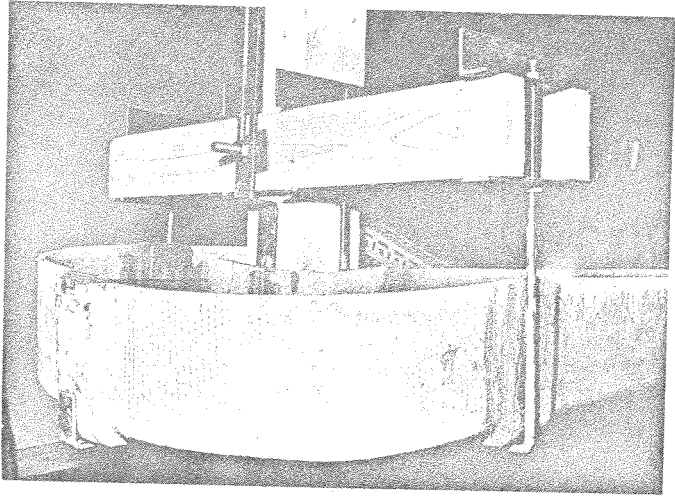

Figure  
15

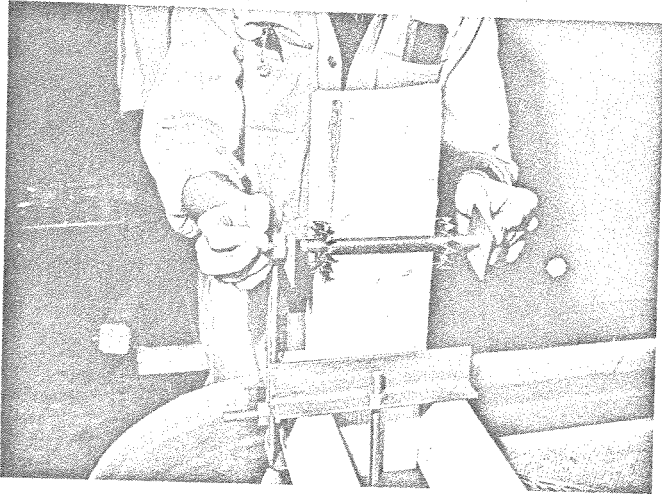
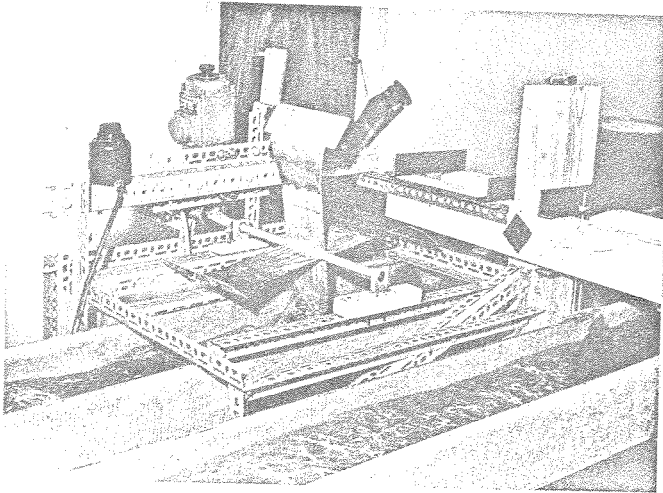
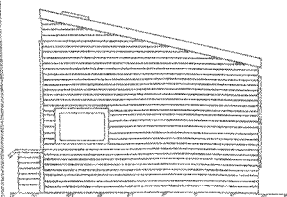
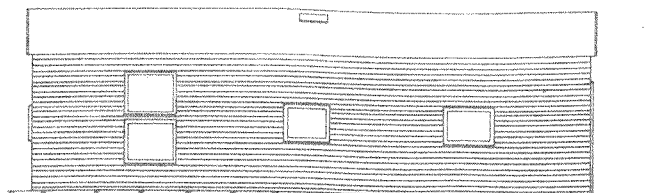

Figure  
16





KORTSIDE ØST



NORSIDE

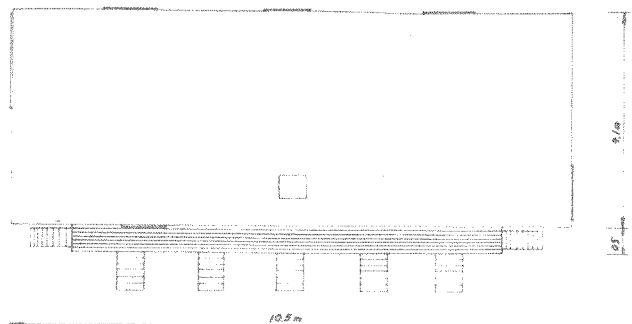

10.5 m

9.1 m

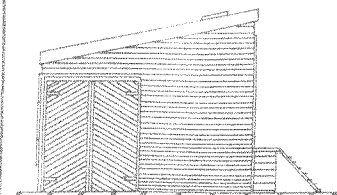

KORTSIDE VEST

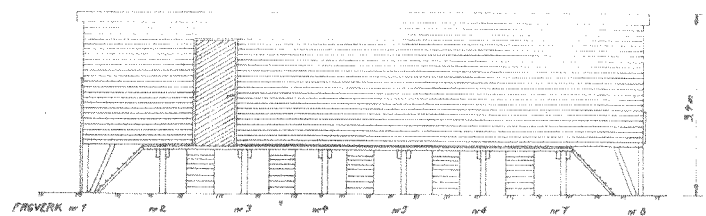

FORSIDE MOT SØR

3.7 m

FAGVERK:  
nr 1, 2, 3, 6, 7, 8 iflg. tegn. 14904  
nr 4 og 5 iflg. tegn. 14905  
VINDUER:  
3 stk 1 fogs enkle 100x60 cm  
2 stk 1 fogs enkle 100x80 cm  
TRAPPER OG RAMPE: av 9 1/2"  
Dør:  
90x200 cm med trefylling.  
TAKLUKE: iflg. 14905

Driftsbygning for forsøksanlegg Kjeller.	Målestokk	Tegn. L. Rind 1/4 - 60
	1:50	Trac.
NORSK INSTITUTT FOR VANNFORSKNING	Erstatning for:	14903.
	Erstatning av:	

1000 1000

DETALJE AV  
TAKLUKKE

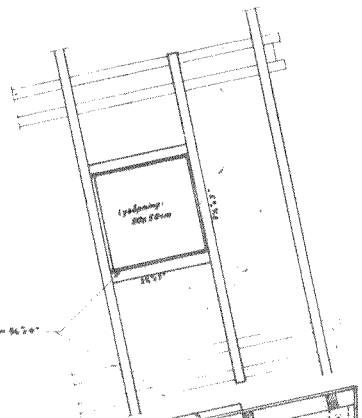

Luftklemme 50x50

1200mm  
1200mm

1000mm

Underparten i figuren nr 4 og 5 ses ikke frem. Disse er  
 forarbejdet de med en 2 1/2" dybde. Efter at indføre  
 de sømme (Sjette nr. 1000)  
 TÅKLUKKE: Befælt pappe afles og over sømme.  
 Deles med pappeklud lene som på utvedt sømme

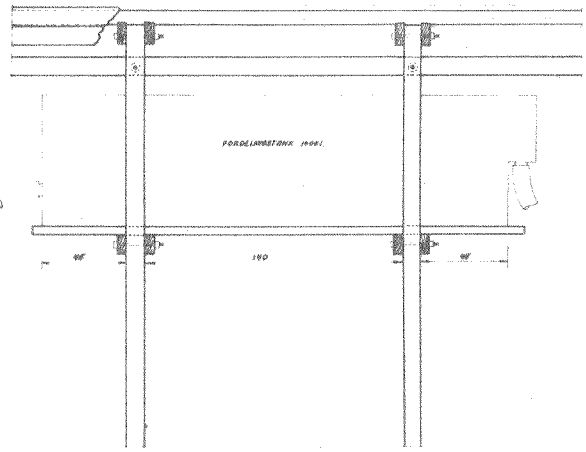
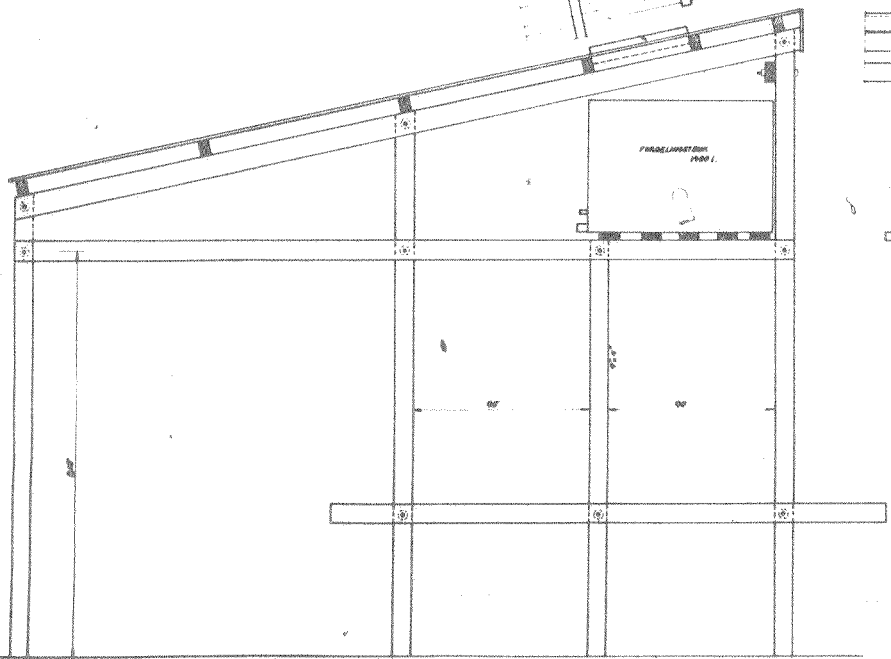

BLÅ RØD I CY

BÆREKONSTRUKSJON NR. 4 og 5	Skala	1:10
	1:10	
NORSK INSTITUTT FOR VANNFORSKNING.	Prosjekt nr.	14905
	Blad nr.	

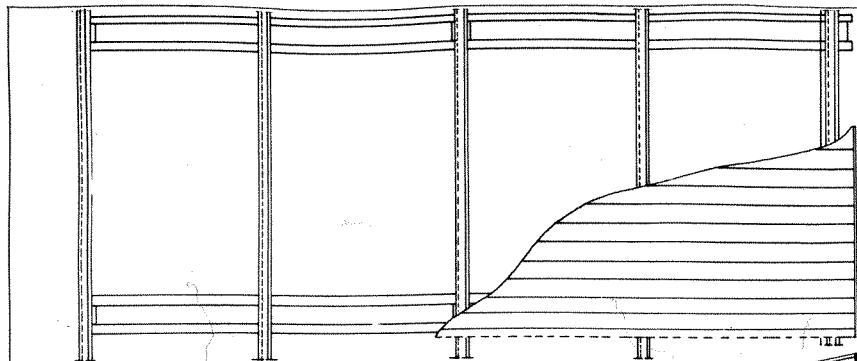

Boltesforbindelser:  
 2" Bulldog 1/2" bolter 22 cm lange  
 2"x2" firkantede underlagskiver.

Taket:  
 Vind dekkes med 1 lag spikret asfaltpapp  
 med tette skjlder.

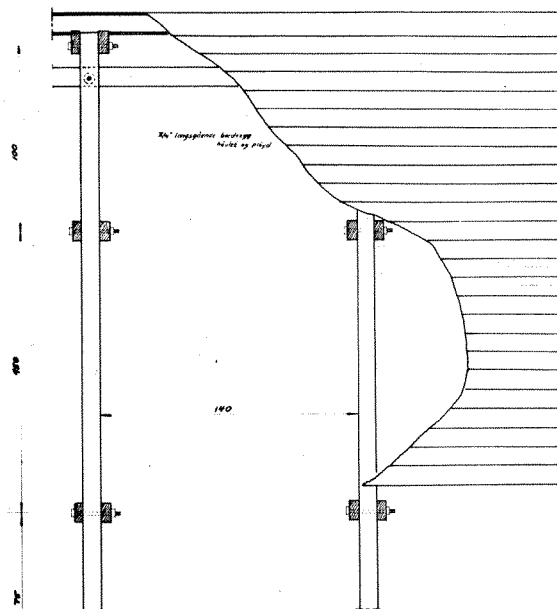
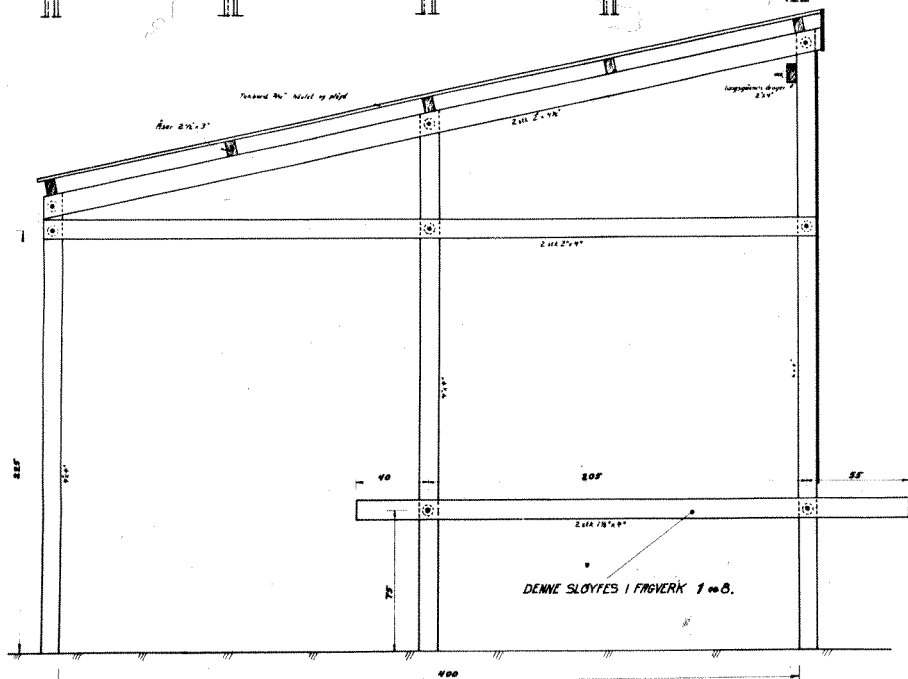

Alle mål i cm.

BÆREKONSTRUKSJON NR. 123678.	Skala	1:10
	Blått	
NORSK INSTITUTT FOR VANNFORSKNING	Prosjekt nr.	14904.
	Blått	

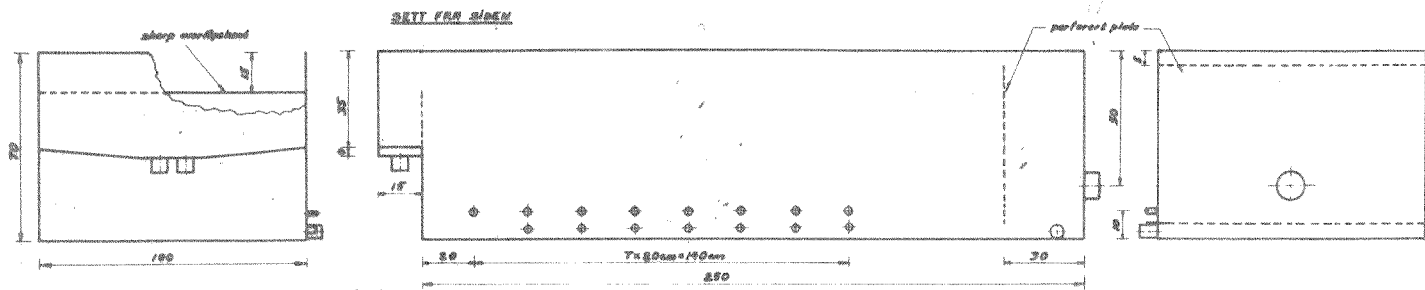

OVERBLET (SÅ DEL AV SINDRESGÅ GJENNOMSIGNET)

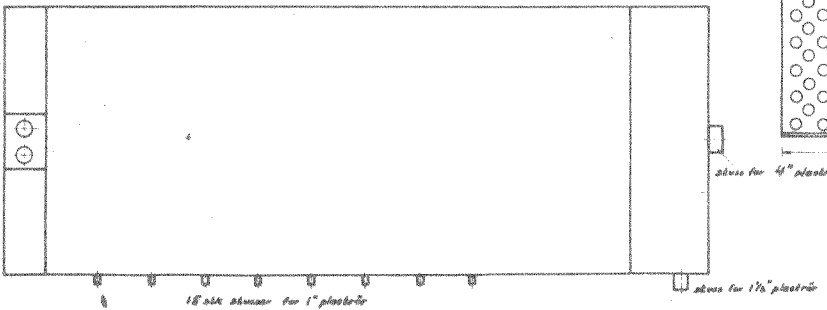

SETT ØVERFRÅ

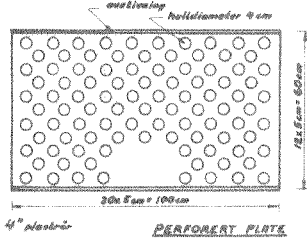

ALLE MÅL I CM.

Fordelingstank av plast til forsøksanlegg	Antallet	Toppl. Antall	16/6-68
	1:10	Trac.	
NORSK INSTITUTT FOR VANNFORSKNING	Etablering for:		
	14902		
Etablert av:			



**DETALJE AV RENNEUTLØP M=1:10**

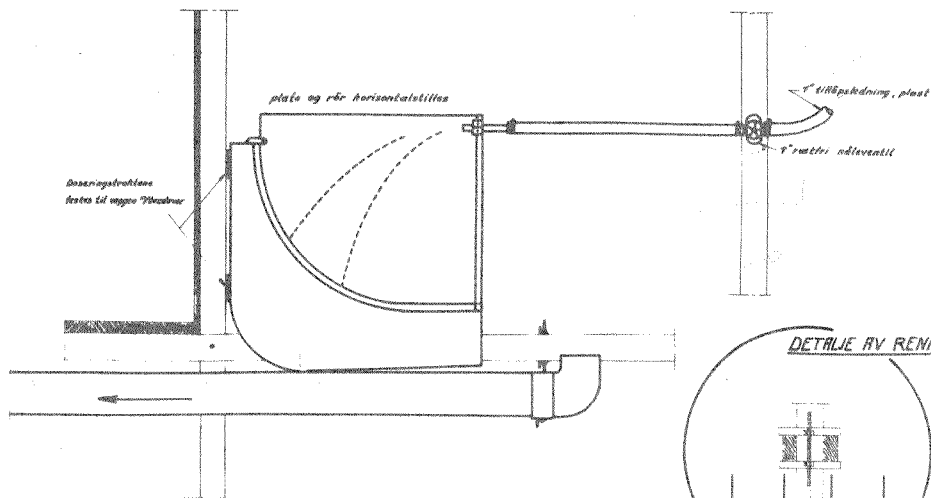

**VANNFØRINGSMÅLER M=1:10**

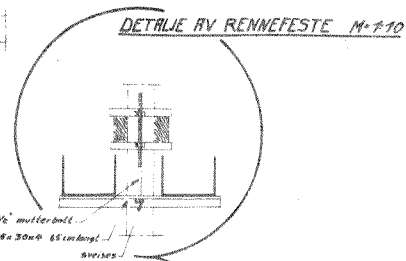

**DETALJE AV RENNEFESTE M=1:10**

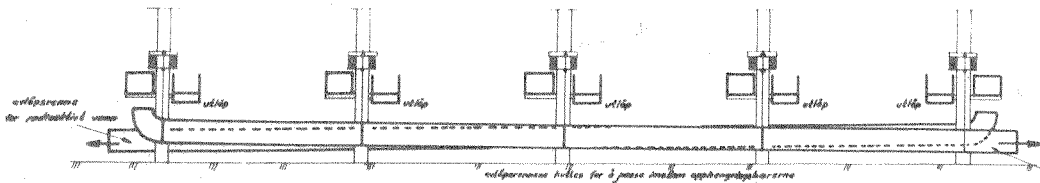

**AVLØPSRENNER FOR RENT- OG RADIOAKTIVT VANN M=1:20**

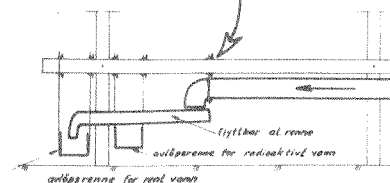

Innrednings tegning

Målestokk	Tegn. L. Red.	1/2-60
M 0	Trac.	
1:20	Kb.	
1:10		

NORSK INSTITUTT  
FOR VANNFORSKNING

14908.

Erstatet av:

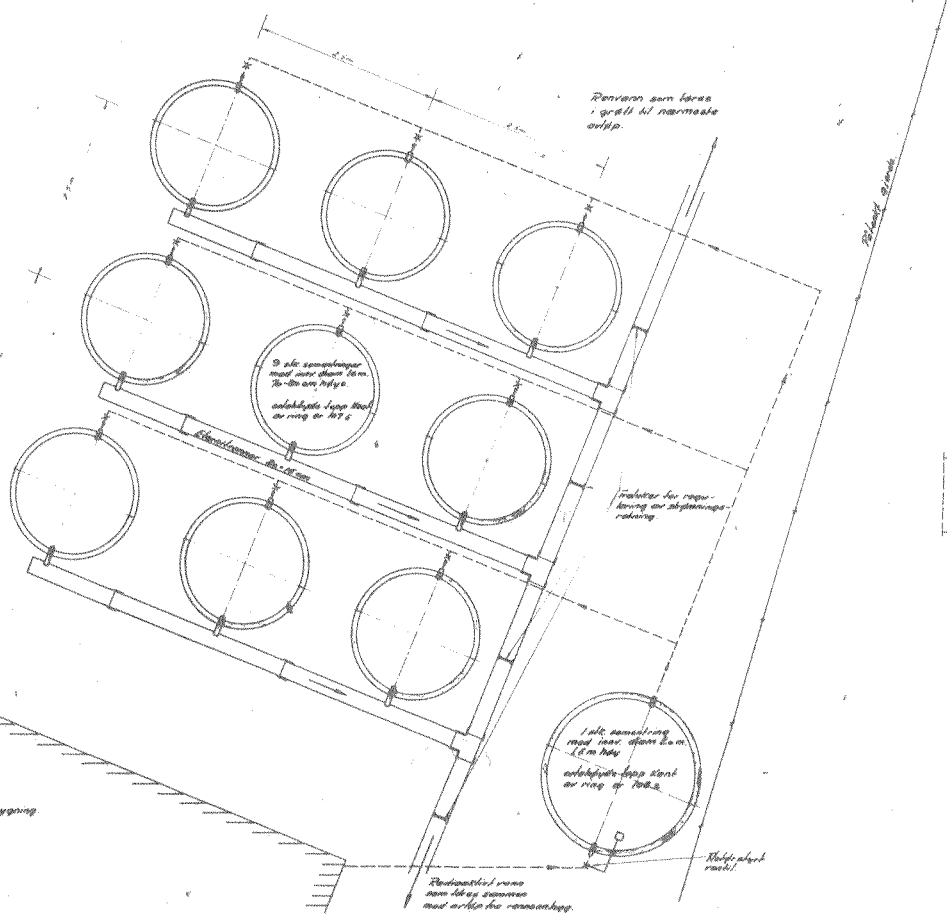

Revnen som løses i grøft til nærmeste omløb.

3 stk sømstænger med størrelse 16 mm 20-20 cm højde udførelse ligger kant er ring er 100 g

Plakater for registrering af afslutningsretning

1 stk sømstænger med størrelse 16 mm 20-20 cm højde udførelse ligger kant er ring er 100 g

Rektangulært søm som løses sammen med arbjør for sømstænger.

Højde af kant

Del græves til nedbrændt masse og planeres under alle sømstænger. Fyldning med 10 cm tykt sandlag for disse sættes på plads. Opførelse med kur-stavler under slænteretter for 3 g i højde som korresponderer med arbjør for sømstænger.

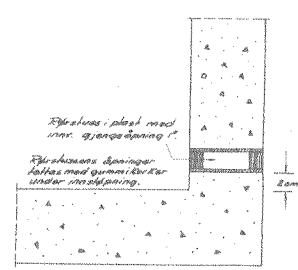

Fyldning med 10 cm tykt sandlag

Fyldning med 10 cm tykt sandlag

Detalje af sømstænger planering i sømstænger M-172

--- søm i planering for kontrol af revnen for brudens

Føjediameter for sømstænger i Kjeller.	1225	1225	1225
	112	112	112
År at bestilt for konstruktør	14911		